

## LINEARlight Rigid FINESSE – Accessories

Módulos LED rígidos para aplicaciones profesionales



### Beneficios del producto

- Large set of accessories for installation
- Recessed kit for installation on false ceiling
- Wall arms for holding fixture in place
- Metal clip for surface installation
- Kit for pendant installation
- Indoor and outdoor jumper for daisy chain connection
- Indoor and outdoor power cable: 5 m
- Outdoor male and female terminals for ad hoc cabling



## Hoja de datos gama de productos

### Datos técnicos

Descripción del producto	Datos eléctricos	Dimensiones y peso		Datos logísticos
	Tipo de corriente	Largo	Peso del producto	Número estadístico de material
LR FINESSE DIY M/F IP68	corriente continua (CC)	54 mm	85,00 g	853669909900
LR FINESSE IN CABLE 5m IP54	corriente continua (CC)	5038 mm	326,00 g	854442909000
LR FINESSE IN CABLE 5m IP68	corriente continua (CC)	5108 mm	447,00 g	854442909000
LR FINESSE JUMPER 0.5m IP68	corriente continua (CC)	608 mm	274,00 g	854442909000
LR FINESSE JUMPER 1m IP54	corriente continua (CC)	1079 mm	72,00 g	854442909000
LR FINESSE RECESSED KIT	corriente continua (CC)	1600 mm	360,00 g	732690989000
LR FINESSE SUSPENSION KIT	corriente continua (CC)	3000 mm	80,00 g	732690989000
LR FINESSE WALL ARMS	corriente continua (CC)	320 mm	300,00 g	732690989000
LR FINESSE METAL CLIP	corriente continua (CC)	30 mm	5,00 g	732690989000

## Hoja de datos gama de productos

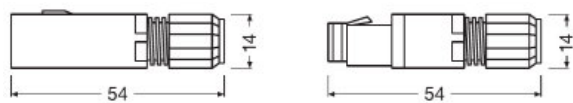

LR FINESSE DIY MF DRAW 171219



LR FINESSE DIY MF DRAW 171219

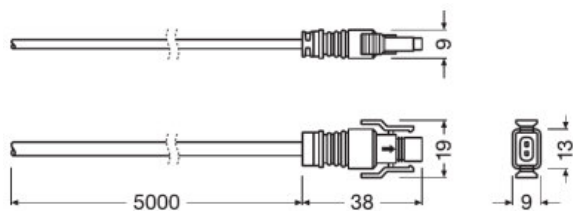

LR FINESSE IN CABLE 5M IP54 DRAW 171219

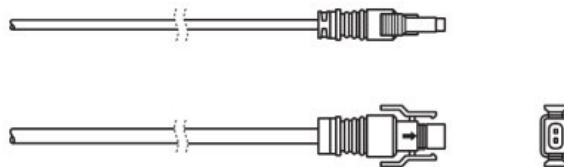

LR FINESSE IN CABLE 5M IP54 DRAW 171219



LR FINESSE IN CABLE 5M IP68 DRAW 171219



LR FINESSE IN CABLE 5M IP68 DRAW 171219

Hoja de datos gama de productos

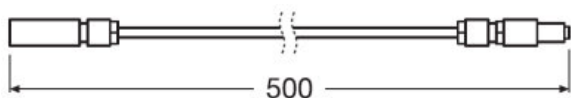

LR FINESSE JUMPER 0.5M IP68 DRAW 171219

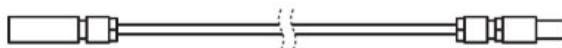

LR FINESSE JUMPER 0.5M IP68 DRAW 171219

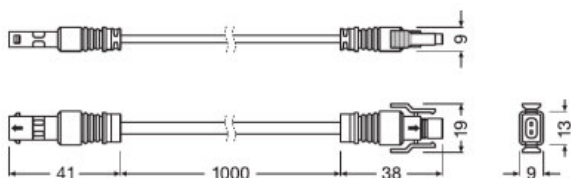

LR FINESSE IN JUMPER 1M IP54 DRAW 171219

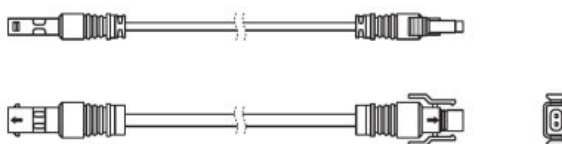

LR FINESSE IN JUMPER 1M IP54 DRAW 171219

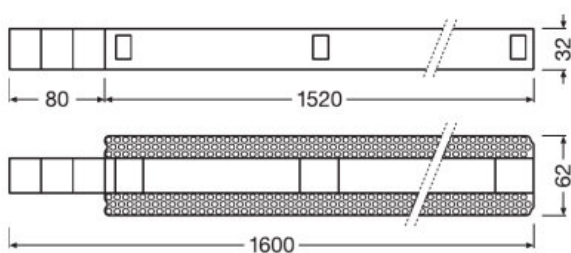

LR FINESSE RECESSED KIT DRAW 290120

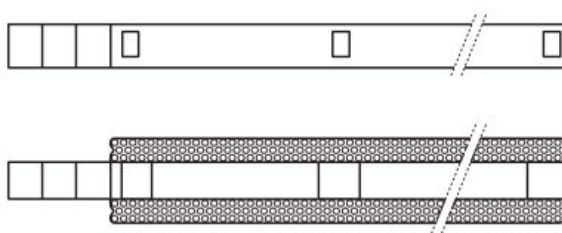

LR FINESSE RECESSED KIT DRAW 290120

## Hoja de datos gama de productos

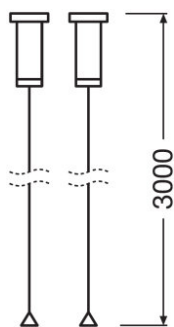

LR FINESSE SUSPENSION KIT DRAW 171219



LR FINESSE SUSPENSION KIT DRAW 171219

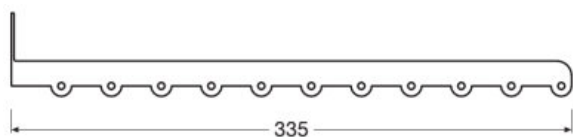

LR FINESSE Wall Arms DRAW 171219

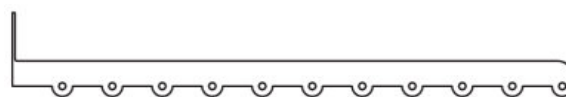

LR FINESSE Wall Arms DRAW 171219

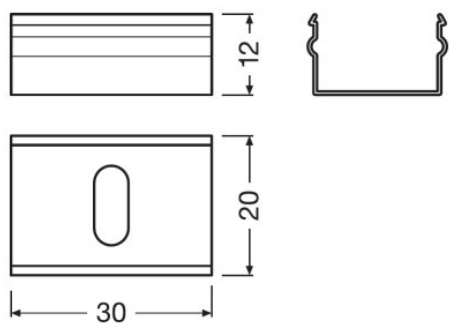

LR FINESSE Metal Clip

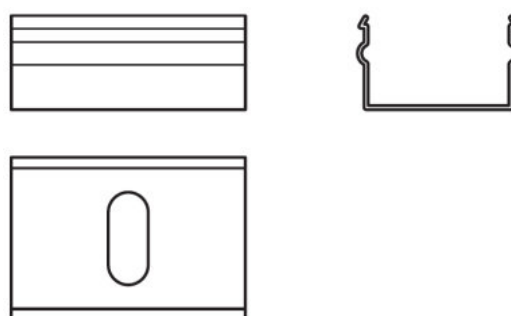

LR FINESSE Metal Clip

## Hoja de datos gama de productos



### Consejos de aplicación

Para más información detallada sobre la aplicación y gráficos vea la hoja de datos del producto.

### Soporte ventas y técnico

Soporte ventas y técnico [www.osram.es](http://www.osram.es)

### Descarga datos

Fichero	
	User instruction FINESSE
	User instruction FINESSE Recessed Kit

### Logistical Data

Código del producto	Descripción del producto	Unidad de embalaje (Piezas/unidad)	Dimensiones (largo x ancho x alto)	Volúmen	Peso bruto
4052899618169	LR FINESSE DIY M/F IP68	Embalaje de envío 10	200 mm x 200 mm x 100 mm	4.00 dm <sup>3</sup>	1010.00 g
4052899618121	LR FINESSE IN CABLE 5m IP54	Embalaje de envío 4	230 mm x 130 mm x 160 mm	4.78 dm <sup>3</sup>	2004.00 g
4052899618138	LR FINESSE IN CABLE 5m IP68	Embalaje de envío 4	290 mm x 190 mm x 160 mm	8.82 dm <sup>3</sup>	2060.00 g
4052899618152	LR FINESSE JUMPER 0.5m IP68	Embalaje de envío 4	200 mm x 200 mm x 100 mm	4.00 dm <sup>3</sup>	1220.00 g
4052899618145	LR FINESSE JUMPER 1m IP54	Embalaje de envío 4	230 mm x 130 mm x 160 mm	4.78 dm <sup>3</sup>	988.00 g
4052899618091	LR FINESSE RECESSED KIT	Embalaje de envío 5	1652 mm x 192 mm x 37 mm	11.74 dm <sup>3</sup>	2160.00 g
4062172114493	LR FINESSE SUSPENSION KIT	Embalaje de envío 30	300 mm x 200 mm x 200 mm	12.00 dm <sup>3</sup>	2642.00 g
4052899618084	LR FINESSE WALL ARMS	Embalaje de envío 2	62 mm x 327 mm x 32 mm	0.65 dm <sup>3</sup>	670.00 g
4052899618107	LR FINESSE METAL CLIP	Embalaje de envío 100	180 mm x 130 mm x 120 mm	2.81 dm <sup>3</sup>	580.00 g

El código del producto mencionado describe la unidad más pequeña de la cantidad que se puede pedir. Una unidad de envío puede contener uno o más productos individuales. Al cursar un pedido, introduzca la cantidad de la unidad de envío o su múltiple.

## Hoja de datos gama de productos

---

### Aviso

Sujeto a cambios sin aviso. Excepto errores y omisiones. Asegúrese de utilizar la emisión más reciente.